

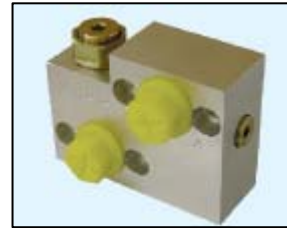

HIDRÁULICA
ROGIMAR

BV R 12/12 VALVULA ANTICAVITACIÓN
MPP-MPR-MPH
CODE: KP4001

DIMENSIONES

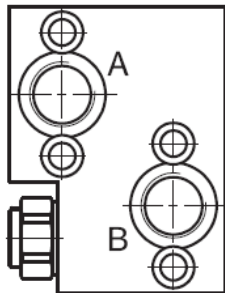
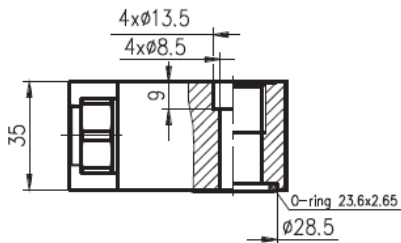
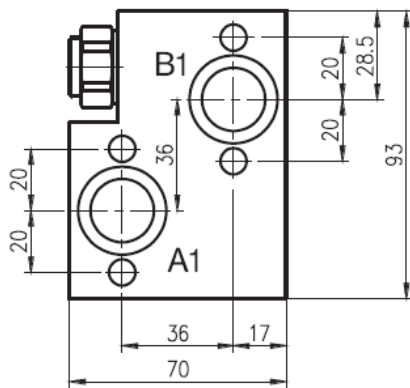

ESQUEMA

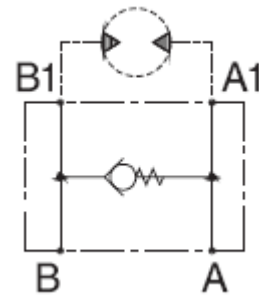

| | |
|---------------|------------|
| PARAMETROS | BD R 12/12 |
| CAUDAL. L/MIN | 50 |
| PRESION MAX | 210 |
| CODIGO | KP4001 |



HIDRÁULICA
ROGIMAR

BV S 12/12 VALVULA ANTICAVITACIÓN

MPS

CODE: KP4002

DIMENSIONES

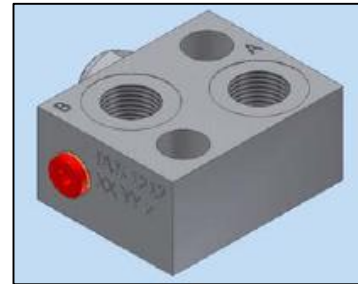
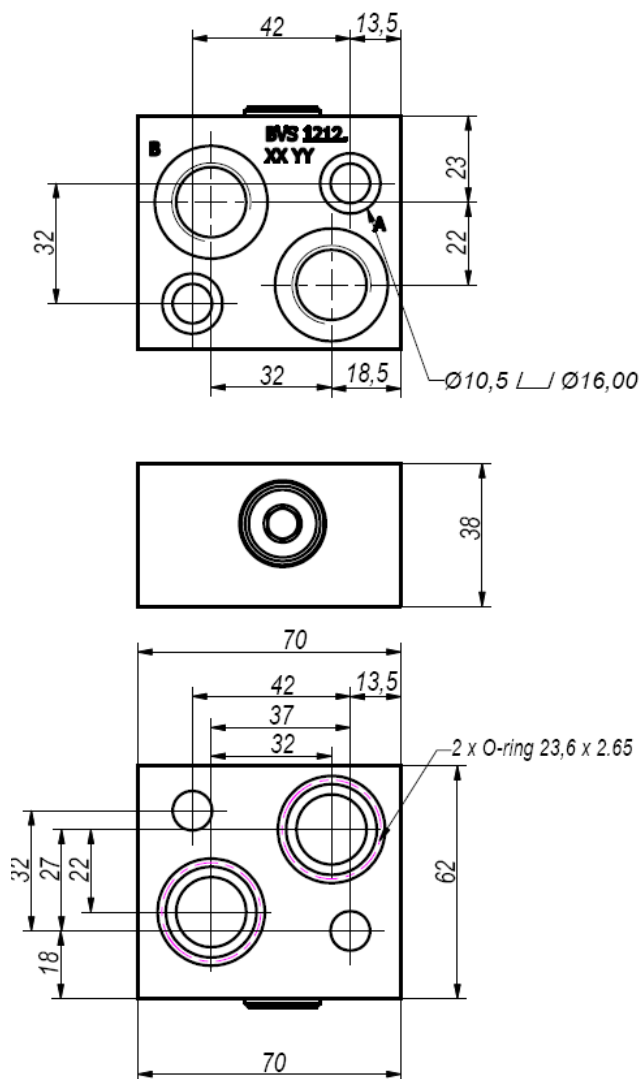

ESQUEMA

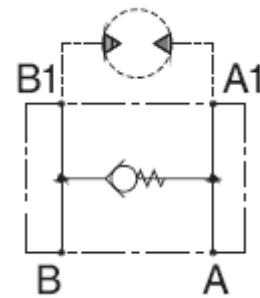

| PARAMETROS | BD S 12/12 |
|---------------|------------|
| CAUDAL. L/MIN | 50 |
| PRESION MAX | 210 |
| CODIGO | KP4002 |